

Карбид вольфрамовые калибрующие втулки и фильеры для волочения труб S30

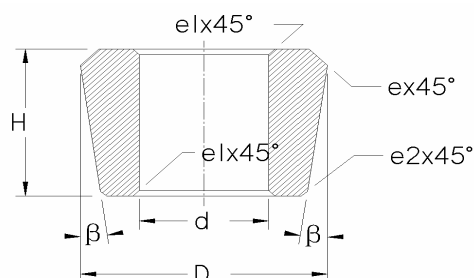
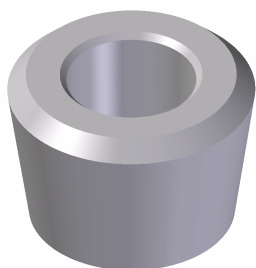

Новый тип	Старый тип	Размеры (мм)				Расчетные размеры (мм)		
		D	H	d	β	e	e_1	e_2
S30-101308-22.0	LS30-22A	22	13	10	8°	1.5	1.0	1.0
S30-121608-23.5	LS30-23	23.5	16	12	8.5°	1.0	1.0	1.0
S30-141608-24.5	LS30-24	24.5	16	14	8.5°	1.0	1.0	1.0
S30-141608-25.5	LS30-25	25.5	16	14	8.5°	1.0	1.0	1.0
S30-141708-27.0	LS30-27A	27	17	14	8.5°	1.5	1.0	1.0
S30-141608-27.5	LS30-27	27.5	16	14	8.5°	2.0	1.0	1.0
S30-172708-28.0	LS30-28	28.0	27	17	8.5°	2.0	1.0	1.0
S30-172708-29.2	LS30-29	29.2	27	17	8.5°	2.0	1.0	1.0
S30-172708-30.4	LS30-30	30.4	27	17	8.5°	2.0	1.0	1.0
S30-172708-31.6	LS30-31	31.6	27	17	8.5°	2.0	1.0	1.0
S30-172708-32.2	LS30-32	32.2	27	17	8.5°	2.0	1.0	1.0
S30-172710-32.8	LS30-32A	32.8	32	12	10°	2.0	2.0	1.5
S30-172708-33.4	LS30-33	33.4	27	17	8.5°	2.0	1.0	1.0
S30-172708-34.0	LS30-34	34.0	27	17	8.5°	2.0	1.0	1.0
S30-133810-34.0	LS30-34A	34.0	38.8	13	10.5°	5.0	2.0	2.0
S30-172708-35.2	LS30-35	35.2	27	17	8.5°	2.0	1.0	1.0
S30-172708-36.4	LS30-36	36.4	27	17	8.5°	2.0	1.0	1.0
S30-192708-37.0	LS30-37	37.0	27	19	8.5°	2.0	1.0	1.0
S30-192708-38.2	LS30-38	38.2	27	19	8.5°	2.0	1.0	1.0
S30-192708-39.4	LS30-39	39.4	27	19	8.5°	2.0	1.0	1.0
S30-212708-40.0	LS30-40	40.0	27	21	8.5°	3.0	1.0	1.0
S30-212708-41.0	LS30-41	41.0	27	21	8.5°	3.0	1.0	1.0
S30-212708-42.0	LS30-42	42.0	27	21	8.5°	3.0	1.0	1.0
S30-212708-43.0	LS30-43	43.0	27	21	8.5°	3.0	1.0	1.0
S30-233208-44.0	LS30-44	44.0	32	23	8.5°	3.0	1.0	1.0
S30-233208-45.0	LS30-45	45.0	32	23	8.5°	3.0	1.0	1.0
S30-233208-46.0	LS30-46	46.0	32	23	8.5°	3.0	1.0	1.0
S30-253208-47.0	LS30-47	47.0	32	25	8.5°	4.0	1.0	1.0
S30-253208-48.0	LS30-48	48.0	32	25	8.5°	4.0	1.0	1.0
S30-253208-49.0	LS30-49	49.0	32	25	8.5°	4.0	1.0	1.0
S30-253208-50.0	LS30-50	50.0	32	25	8.5°	4.0	1.0	1.0

S30-253208-51.0	LS30-51	51.0	32	25	8.5°	4.0	1.0	1.0
S30-253208-52.0	LS30-52	52.0	32	25	8.5°	4.0	1.0	1.0
S30-253208-53.0	LS30-53	53.0	32	25	8.5°	4.0	1.0	1.0
S30-283208-54.0	LS30-54	54.0	32	28	8.5°	4.0	1.0	1.0
S30-283208-55.0	LS30-55	55.0	32	28	8.5°	4.0	1.0	1.0
S30-283208-56.0	LS30-56	56.0	32	28	8.5°	4.0	1.0	1.0
S30-283208-57.0	LS30-57	57.0	32	28	8.5°	4.0	1.0	1.0
S30-283508-58.0	LS30-58	58.0	35	28	8.5°	4.0	1.0	1.0
S30-283508-59.0	LS30-59	59.0	35	28	8.5°	4.0	1.0	1.0
S30-283508-60.0	LS30-60	60.0	35	28	8.5°	4.0	1.0	1.0
S30-283508-61.0	LS30-61	61.0	35	28	8.5°	4.0	1.0	1.0
S30-283508-62.0	LS30-62	62.0	35	28	8.5°	4.0	1.0	1.0
S30-283508-63.0	LS30-63	63.0	35	28	8.5°	4.0	1.0	1.0
S30-283508-64.0	LS30-64	64.0	35	28	8.5°	4.0	1.0	1.0
S30-343509-68.0	LS30-68	68.0	35	34	9°	5.0	3.0	2.0
S30-343509-71.0	LS30-71	71.0	35	34	9°	5.0	3.0	2.0
S30-383509-75.0	LS30-75	75.0	35	38	9°	5.0	3.0	2.0

	2.0
	2.0
	2.0
	2.0
	2.0
	2.0
	2.0
	2.0
	2.0
	2.0
	2.0

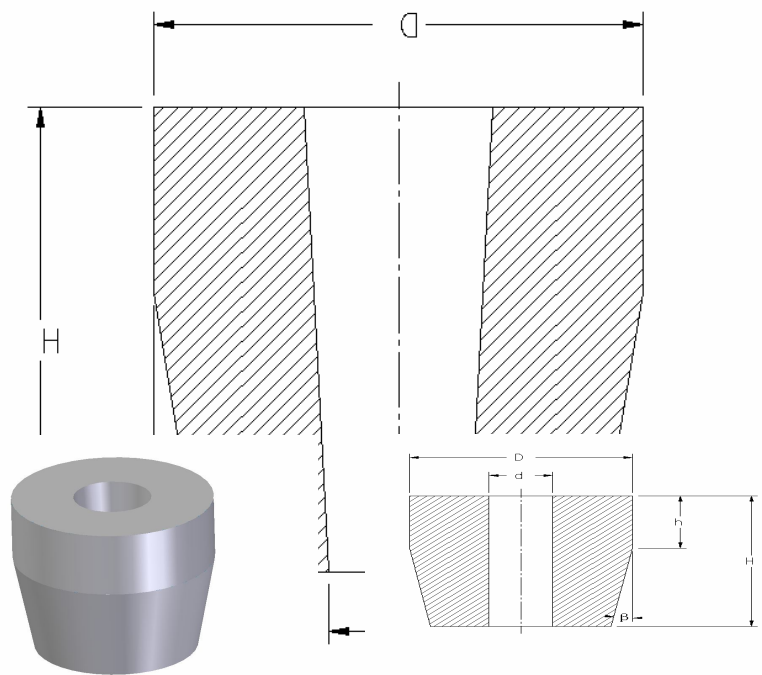

Новый тип	Старый тип	Размеры (мм)			Расчетные размеры (мм)	
		D	H	d	h	β
S30-122108-35.0-A	LS30-35A	35	21	12	7	8°
S30-162308-40.0-A	LS30-40A	40	23	16	7	8°
S30-162508-45.0-A	LS30-45A	45	25	16	7	8°
S30-182808-50.0-A	LS30-50A	50	28	18	7	8°

S30-183008-55.0-A	LS30-55A	55	30	18	7	8°
S30-223208-60.0-A	LS30-60A	60	32	22	7	8°
S30-223408-65.0-A	LS30-65A	65	34	22	7	8°

Карбид вольфрамовые калибрующие втулки и фильеры для волочения труб S30-AB

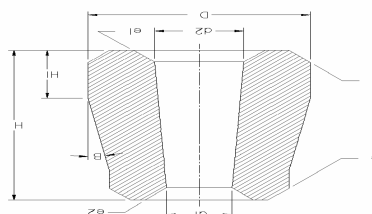
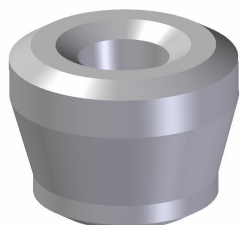

Тип	Размеры (мм)					Расчетные размеры (мм)				
	D	H	H ₁	d	d ₁	e	a	e ₁	e ₂	β
LS30-21AB	21	25	8	18	6	2	2	2.0		9.5°
LS30-20.6AB	20.6	25	8	18.4	6	2	2	2.0		9.5°
LS30-25.2AB	25.2	30	8	21.5	8	2	2	2.0		9.5°
LS30-27AB	27	30	8	24.2	8	2	2	2.0		9.5°
LS30-22.6AB	22.6	32	10.5	20.1	8	R8	2	2.0		10.5°
LS30-10AB	10	25	6	8	4	1	1	1.0		9.5°
LS30-11AB	11	25	6	9	4	1	1	1.0		9.5
LS30-12AB	12	25	6	10	4	1	1	1.0	0.6	9.5
LS30-13AB	13	25	6	10	4	1	1	1.0	0.6	9.5
LS30-14AB	14	25	6	12	4	1	1	1.0	0.6	9.5
LS30-14ABC	14	25	6	11	4	1	1	1.0	0.6	9.5
LS30-15AB	15	25	8	13	6	1	1	1.0	0.6	9.5
LS30-15ABC	15	25	8	12	6	1	1	1.0	0.6	9.5
LS30-16AB	16	25	8	14	6	1.5	1.1	1.5	1.1	9.5
LS30-17AB	17	25	8	14	6	1.5	1.1	1.5	1.1	9.5
LS30-18AB	18	25	8	15	6	1.5	1.1	1.5	1.1	9.5
LS30-18ABC	18	25	8	16	6	1.5	1.1	1.5	1.1	9.5
LS30-19AB	19	25	8	16	8	1.5	1.1	1.5	1.1	9.5
LS30-20AB	20	25	8	18	8	1.5	1.1	1.5	1.1	9.5
LS30-20ABC	20	25	8	17	8	1.5	1.1	1.5	1.1	9.5
LS30-21AB	21	25	8	18	8	1.5	1.1	1.5	1.1	9.5
LS30-22AB	22	25	8	19	8	1.5	1.1	1.5	1.1	9.5
LS30-23AB	23	30	9	20	10	1.5	1.1	1.5	1.1	9.5
LS30-24AB	24	30	9	21	10	1.5	1.1	1.5	1.1	9.5
LS30-25AB	25	30	9	22	10	1.5	1.1	1.5	1.1	9.5
LS30-26AB	26	31	11	22.9	10	1.5	1.1	1.5	1.1	9.5
LS30-26ABC	26	30	9	23	10	1.5	1.1	1.5	1.1	9.5
LS30-27AB	27	30	9	24	10	1.5	1.1	1.5	1.1	9.5
LS30-28AB	28	35	10	25	12	1.5	1.1	1.5	1.1	9.5
LS30-29AB	29	35	10	26	12	1.5	1.1	1.5	1.1	9.5
LS30-30AB	30	35	10	27	12	1.5	1.1	1.5	1.1	9.5
LS30-31AB	31	35	10	28	12	1.5	1.1	1.5	1.1	9.5

Карбид вольфрамовые калибрующие втулки и фильеры для волочения труб S31

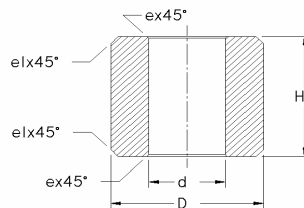
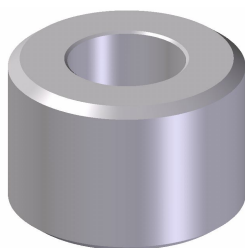

Новый тип	Старый тип	Размеры (мм)			Расчетные размеры (мм)	
		D	H	d	e ₁	e
S31-0142500-7.0	S31-14	14	25	7.0	1.0	0.5
S31-0152500-7.0	S31-15	15	25	7.0	1.0	0.5
S31-0162500-7.0	S31-16	16	25	7.0	1.0	0.5
S31-0172500-8.0	S31-17	17	25	8.0	1.0	0.5
S31-0182500-8.0	S31-18	18	25	8.0	1.0	0.5
S31-0193000-10.0	S31-19	19	30	10.0	1.0	0.5
S31-0203000-10.0	S31-20	20	30	10.0	1.0	0.5
S31-0213000-10.0	S31-21	21	30	10.0	1.0	0.5
S31-0223000-10.0	S31-22	22	30	10.0	1.0	0.5
S31-0233000-12.0	S31-23	23	30	12.0	1.0	0.5
S31-0243000-12.0	S31-24	24	30	12.0	1.0	0.5
S31-0253000-12.0	S31-25	25	30	12.0	1.0	0.5
S31-0263000-12.0	S31-26	26	30	12.0	1.0	0.5
S31-0273000-12.0	S31-27	27	30	12.0	1.0	0.5
S31-0283500-16.0	S31-28	28	35	16.0	1.0	0.5
S31-0293500-16.0	S31-29	29	35	16.0	1.0	0.5
S31-0303500-16.0	S31-30	30	35	16.0	1.0	0.5
S31-0313500-16.0	S31-31	31	35	16.0	2.0	0.5
S31-0323500-16.0	S31-32	32	35	16.0	2.0	0.5
S31-0333500-20.0	S31-33	33	35	20.0	2.0	0.5
S31-0343500-20.0	S31-34	34	35	20.0	2.0	0.5
S31-0353500-20.0	S31-35	35	35	20.0	2.0	0.5
S31-0363500-20.0	S31-36	36	35	20.0	2.0	0.5
S31-0373500-20.0	S31-37	37	35	20.0	2.0	0.5
S31-0383500-20.0	S31-38	38	35	20.0	2.0	0.5
S31-0393500-20.0	S31-39	39	35	20.0	2.0	0.5
S31-0403500-20.0	S31-40	40	35	20.0	2.0	0.5
S31-0413500-20.0	S31-41	41	35	20.0	2.0	0.5
S31-0423500-20.0	S31-42	42	35	20.0	2.0	0.5
S31-0434000-22.0	S31-43	43	40	22.0	2.0	0.5
S31-0444000-22.0	S31-44	44	40	22.0	2.0	0.5

S31-0454500-26.4	S31-45	45	45	26.4	2.0	0.5
S31-0464500-26.4	S31-46	46	45	26.4	2.0	0.5
S31-0474500-26.4	S31-47	47	45	26.4	2.0	0.5
S31-0484500-26.4	S31-48	48	45	26.4	2.0	0.5
S31-0504500-26.4	S31-50	50	45	26.4	2.0	0.5